

LiftPlanner

A 3D Crane and Rigging lift planning system that runs inside of AutoCAD Release 2004 through 2009 and Windows XP or Vista. LiftPlanner includes programs for generating the lift environment as well as cranes, gantries, platform trailers and rigging. Drawings are created to plan and document your critical lift, heavy haul, alternate lift and rigging projects.

Lift Movie

A 3D Crane and Rigging lift simulation system that works in tandem with LiftPlanner. It is used for client presentation and to rehearse the crew prior to the lift. Lift Movie realistically shows the lift before it happens. Includes software for rendering and animation.

LiftPlanner has all the tools that you need to:

make vessels

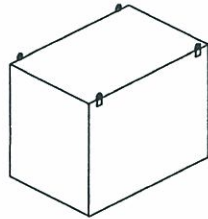
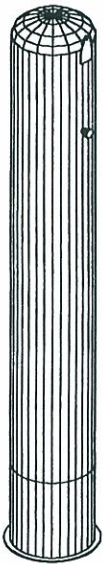

and other objects

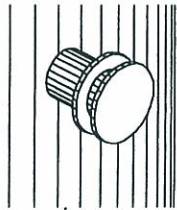

attach trunnions

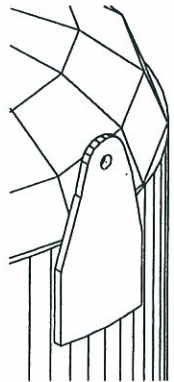

attach lugs



add 6 through 700 ton shackles

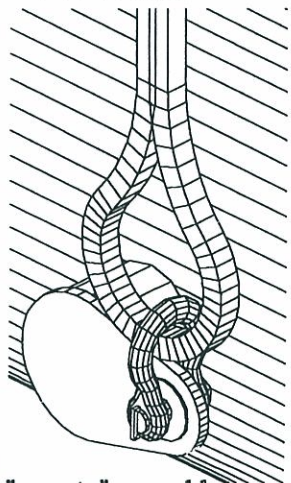

"snap to" assembly

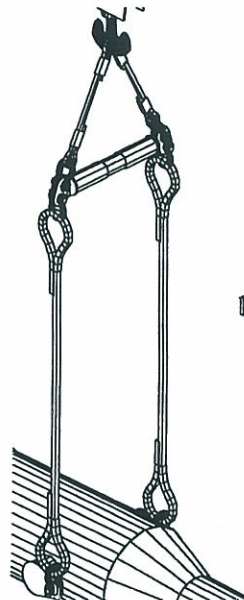

build "complex" rigging

LiftPlanner has all the cranes that you need :

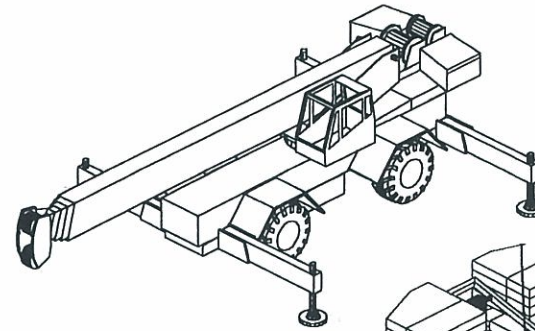

from RT's

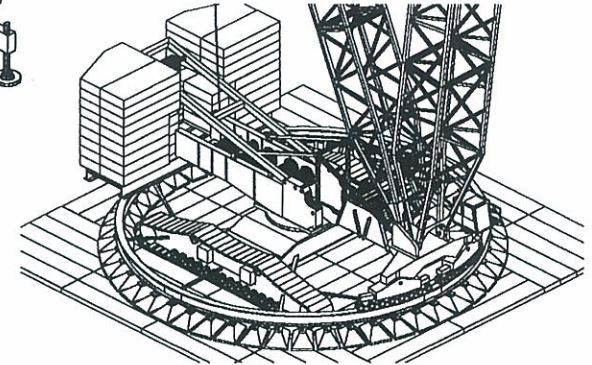

to Ringers

Cranes

- Includes pre-built 3D models of the user's crane fleet.
- Includes routines to:

Configure the crane	Move the crane	Swing
Set Hook elevation	Boom up or down	Telescope
Add or change jib	Change Jib angle	Provide gross capacity
- The user inputs known or trial data such as boom length, radius and hook elevation. The program automatically returns boom angle and tip sheave height to the user.
- Includes a program to retrieve the load chart for the crane configuration.
- Programs are written to warn user of boom extension limits, two blocking, and angle limitations.

Rigging

- Includes 275 pre-built chokers with weight and rating data attached.
- Includes 6 through 700 ton pre-built shackles with weight and rating data.
- A program that inserts skewed chokers and calculates S.W.L. due to angle.
- A program to sum the rigging weights (deductions).

Other

- Beam and column creation programs with A.I.S.C. database of 185 shapes.
- Programs to generate piping, flanges, supports and lugs.

Current library of LiftPlanner cranes:**American**

7260, 7530, 8460, 8470
9270, 9299, 9320, 9510
9310 / Skyhorse
11250 / Skyhorse
11320 / Skyhorse
A-1500-HC

Broderson

IC-35-2B, IC-80-F
IC-180, IC-200-3F

Manitowoc

3900W,3900T,4000W /Twr
4100 S1,S2, Twr.,Ring
4600 S-4,5 / Ring / Twr
M-250/Maxer, M-250T
M-1200 Ring, 111, 555
2250, 2250/2000 Maxer
888-S1&2, 888Ring,
777, 777T, 999 S-1,2,3
12000, 16000/Maxer
18000/Maxer, 21000/Maxer

Galion Hyco Kato

150FA RT121 NK500Bv

Grove

AT422,700B,750B,1100,1300
GMK3050,3055,4070,5120B
GMK5130L, 5150B, 5165
GMK5175,5210,5240,6220
GMK6250/L,6300, 6300/B
GMK6350/ML, GMK7550/ML
RT58D,522B,530E, 630B
RT635C,740,740B,
RT745,750, 750E, 755
RT760E, RT855B, RT860
RT865, 870, 880, 890, 890E
RT990, RT9100, RT9130E
TM890,1275,1300,2500,9120
TMS300,475/LP,865, 875c
TMS890, 800E, 900E

P & H

5150R, 5250, 5300R
790B-TC, 9125TC
Alpha, CN 165

Krupp

KMK2025, KMK3045,
70 GMT AT, 100GMT,
140 GMT AT, 180 GMT
4070, 4080, 4085, 5090
5110, 6140, 6275, 8350

Liebherr

LR1600,LR1400/1,1400/2
LR1300/SL, LR1280/SL
LR1200,LR1160,LR1130
LR1100, HS 853HD
LTM 1500,1400,1400-7.1
LTM1300,1300-6.1,1250-6.1
LTM1225-5.1, 1220-5.1
LTM1200/1,1200,1160/2
LTM1160, 1160-5.1, 1140,
LTM1120/1,1100/2, 1100,
LTM1095-5.1,1090/2,1080/1
LTM1070-4.1,1070/1, 1055
LTM1055-3.1&3.2, 1050/1
LTM1045-3.2, 1040-2.1

Lorain Lima Mantis

MC-8150 7700,7707 10010

Platform Trailers

Scheuerle, Goldhofer
Super Vario

Terex

RT160,175,190,230,335
RT555-1, RT780, 5120
T340,T340-1L,T560,T750

Riggers Manufacturing

TL150BW Trilifter

Gantries

Lift Systems 44A, 24PT500LT, 34PT500WT
J&R 700-28, 903-34LD, T1402-39, Riggers EZ-400

Link Belt

ATC-3130, HSP-8022, 8040
RTC-8060, 8064, 8065
HTC-830, 1170, 8640, 8650,
HTC-8665, 8670, 8690
HTC-11100, RTC-80100
LS-138H, LS-218, LS-308H5
LS-518, LS-718 / Ring
LS-818 / Ring, LS-918 / Ring
LS-1018, HC-138H, HC-218
HC-218A, HC-228H, HC-238A
HC-238H Series II
HC-248H HC-258
HC-268 HC-278H

Demag

AC35, AC35L, AC40-1, AC50,
AC80-1, AC80-2, AC100-L
AC120, AC125, AC155, AC200-1
AC205, AC265, AC300-1, AC335,
AC350-1/SL, AC395, AC395/1
AC400-1/SL, AC435, AC615, AC615S
AC1200/SL, AC1300/SL, AC1600/SL
HC810, HC920, HC1010, CC1200/SL
CC1800/SL, CC2000/SL, CC2400/SL
CC2500/SL, CC2600/SL, CC2800/SL
TC1200, TC2000/SL
TC 3000/SL, TC3200/SL
TC4000, CC4000/Ring, CC4800

Tadano

ATF50-3, ATF65G-5, ATF160G-5
ATF220G-5, TR-280XL, TR-300XL
TR-350XL, TR-350XL-3, TR-450XL
TR500E TR-500XL-3
TR-500M TR-600XL
TR-600XL-3 TR-650XXL-3

Specify any crane and we will build it.

See website: www.liftplanner.net for current crane list

"Demo" program is available - needs AutoCAD to run.

LiftPlanner®

105 Geneva Blvd.

Burnsville, MN 55306

Email: jimmeehan@liftplanner.net

Phone/fax: (952) 435-6126